

# CLEANMAX

## OPERATING INSTRUCTIONS

FOR CLEANMAX NITRO  
UPRIGHT VACUUM

MODEL :  
CMNR-QD



Before operating the vacuum,  
please read these instructions completely.

# Index

Important Safety Instructions . . . . .	.2
Grounding Instructions . . . . .	.3
Parts Identification . . . . .	.4
Replacement Bags, Belts and Filters . . . . .	.4
How to Assemble and Operate the Vacuum . . . . .	.5
How to Adjust the Handle . . . . .	.5
How to Attach the Extension Power Cord . . . . .	.6
Nozzle Height Feature . . . . .	.6
Edge Cleaning Feature . . . . .	.6
How to Change the Vacuum Bag . . . . .	.6
How to Change the Filters . . . . .	.7
Cleaning with On-Board Tools . . . . .	.7
How to Replace the Vacuum Belt . . . . .	.8
Thermal Motor Protection . . . . .	.9
Troubleshooting . . . . .	.10
For Best Performance . . . . .	.10
Warranty . . . . .	.11
Owner's Information . . . . .	.11

## Save These Instructions

Before you plug in your CleanMax vacuum cleaner, make sure the voltage indicated on the rating plate located on the back of the vacuum cleaner is the same as your local supply.

# IMPORTANT SAFETY INSTRUCTIONS

## SAVE THESE INSTRUCTIONS. **WARNING!** To reduce the risk of fire, electric shock, or injury:

1. Do not leave appliance unattended when plugged in. Unplug from outlet when not in use and before servicing.
2. **WARNING: ELECTRIC SHOCK COULD OCCUR IF USED OUTDOORS OR ON WET SURFACES.**
3. Do not allow to be used as a toy. Keep children and unauthorized persons away from the machine when in use.
4. Use only as described in this manual. Use only manufacturer's recommended attachments.
5. Do not use with damaged cord or plug. If appliance is not working as it should, has been dropped, damaged, left outdoors, or dropped into water, return it to a service center.
6. **WARNING** - The replacement or repair of damaged wiring should only be performed by a qualified electrician or service engineer from the original distributor or authorized service agent.
7. Do not pull or carry by cord, use cord as a handle, close a door on cord, or pull cord around sharp edges or corners. Do not run appliance over cord. Keep cord away from heated surfaces.
8. Do not unplug by pulling on cord. To unplug, grasp the plug, not the cord.
9. Do not handle plug or appliance with wet hands.
10. Turn off all controls before unplugging.
11. Do not put any object into openings. Do not use with any opening blocked; keep free of dust, lint, hair and anything that may reduce air flow.
12. Keep hair, loose clothing, fingers and all parts of body away from openings and moving parts.
13. Do not pick up anything that is burning or smoking, such as cigarettes, matches or hot ashes.
14. Do not use without vacuum bag and/or filters in place.
15. Use extra care when cleaning on stairs.
16. Do not use to pick up flammable or combustible liquids such as gasoline or use in areas where they may be present.
17. Do not attempt to service the unit while appliance is plugged in.
18. For grounded models, connect to a properly grounded outlet only. See Grounding Instructions.
19. This machine is not intended for use by persons (including children) with reduced physical, sensory or mental capabilities, or lack of experience and knowledge, unless they have been given supervision or instruction concerning use of the machine by a person responsible for their safety. Keep children and unauthorized persons away from the machine when in use.
20. To reduce the risk of personal injury due to a loose electrical connection between the appliance plug and extension cord, firmly attach the appliance plug to the extension cord. Periodically check the connection while operating to ensure it is fully attached. Do not use an extension cord that provide a loose connection. A loose connection may result in overheating and increases the risk of burning.
21. To reduce the risk of disconnection of the appliance plug from the extension cord during operating, secure the extension cord to the appliance plug as shown in the operating instructions.
22. Maintain appliance with care. Inspect the extension cords periodically and replace if damaged.

# Grounding Instructions

This appliance must be grounded. If it should malfunction or break down, grounding provides a path of least resistance for electric current to reduce the risk of electric shock. This appliance is equipped with a cord having an equipment-grounding conductor and grounding plug. The plug must be plugged into an appropriate outlet that is properly installed and grounded in accordance with all local codes and ordinances.

This appliance is for use on a nominal 120 volt circuit and has a grounding attachment plug that looks like the plug illustrated in Fig. 1. Make sure that the appliance is connected to an outlet having the same configuration as the plug.

No adapter should be used with this appliance.

**WARNING** - Improper connection of the equipment-grounding conductor can result in a risk of electric shock. Check with a qualified electrician or service person if you are in doubt as to whether the outlet is properly grounded. Do not modify the plug provided with the appliance. If it will not fit the outlet, have a proper outlet installed by a qualified electrician.

The replacement or repair of damaged wiring should only be performed by a qualified electrician or service engineer from the original distributor or authorized service agent

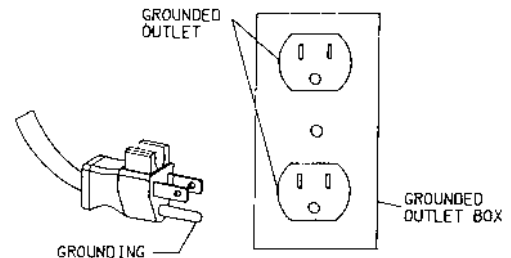

Fig. 1

State of California Proposition 65 Warnings:

WARNING: This product contains one or more chemicals known to the State of California to cause cancer.

WARNING: This product contains one or more chemicals known to the State of California to cause birth defects or other reproductive harm.

# Parts Identification

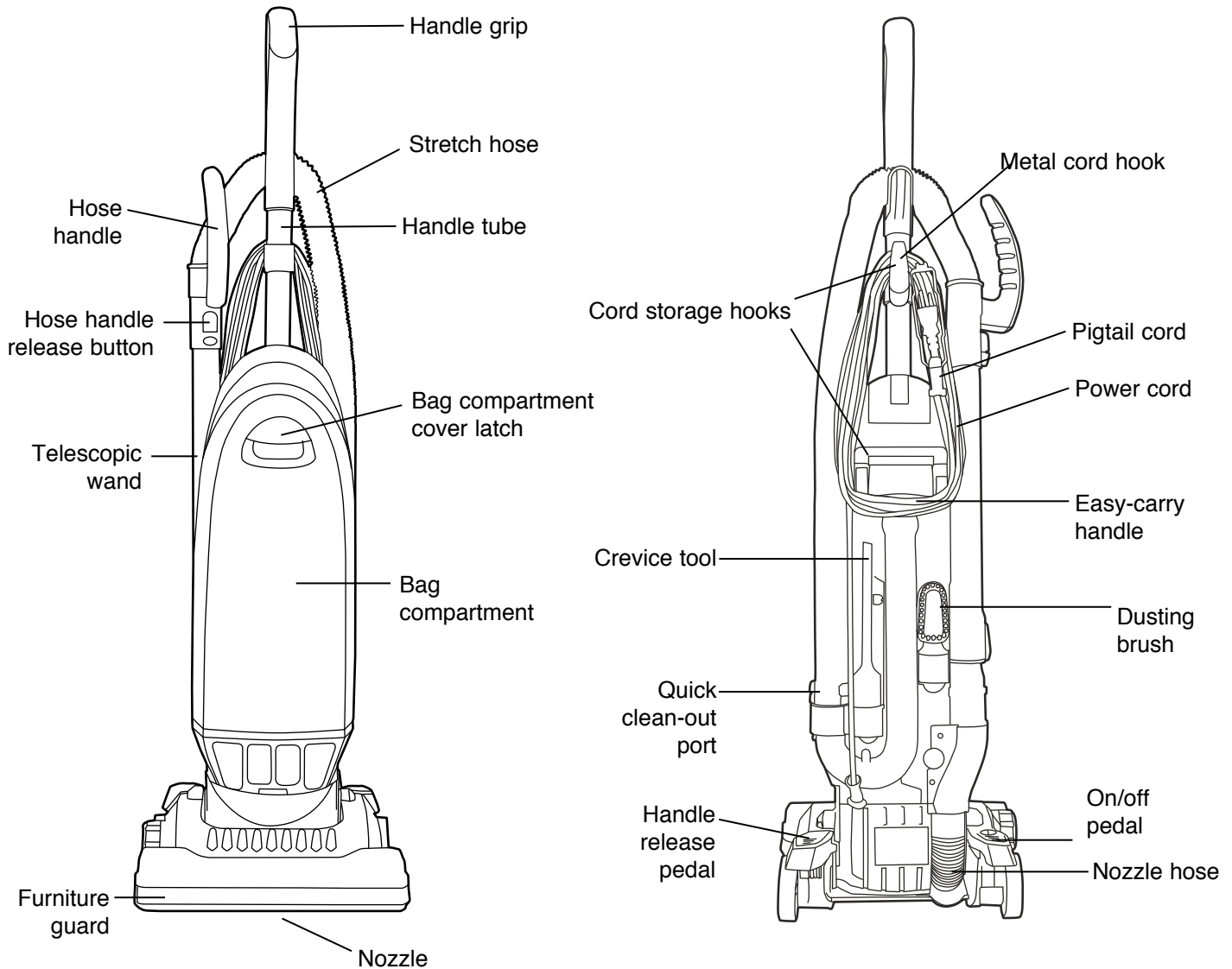

## Replacement Bags, Belts and Filters

- Genuine CleanMax Paper Bags  
Part # CMP-12, 12 per package
- Genuine CleanMax HEPA Media Bags  
Part # CMH-6, 6 per package
- Genuine CleanMax Belts  
Part # CMNR-B2, 2 per package
- Genuine CleanMax Filter Set  
Part # CMNR-F

# How to Assemble and Operate the Vacuum

## How to Attach the Handle to the Vacuum Cleaner

The vacuum and the handle are packed separately.

1. After first removing the handle screw, slide the handle into the slot on top of the vacuum cleaner.
2. Line up the small hole on the handle with the small hole on the vacuum cleaner and insert the screw. Make sure the screw is tightened securely (Fig. 1).

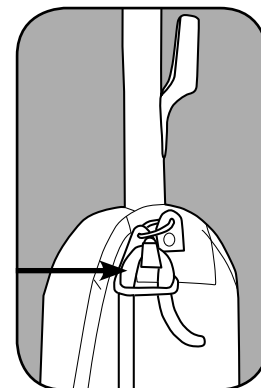

Fig. 1

## On/Off Pedal

1. To turn the vacuum on, push the power pedal on the right side of the vacuum nozzle from the user's perspective (Fig. 2).
2. To turn the vacuum off, push the pedal again.

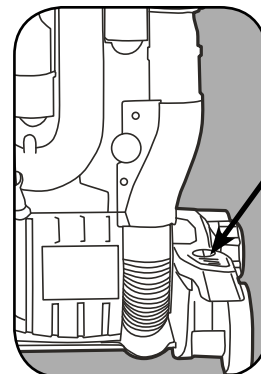

Fig. 2

# How to Adjust the Handle

The handle on this vacuum cleaner can be set to one of three positions – upright, middle or low.

## How to Adjust the Handle

1. To release the handle, step on the handle release pedal on the left side of the vacuum cleaner nozzle from the user's perspective and pull back the handle (Fig. 1).
2. Upright position – for storage or when cleaning tools are used (Fig. 2). Handle locks in this position.
3. Middle position – for normal cleaning (Fig. 3).
4. Low position – for cleaning under furniture (Fig. 4).

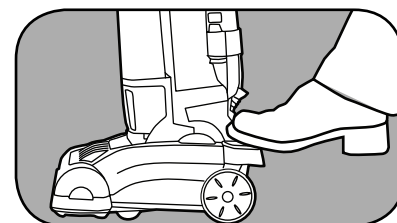

Fig. 1

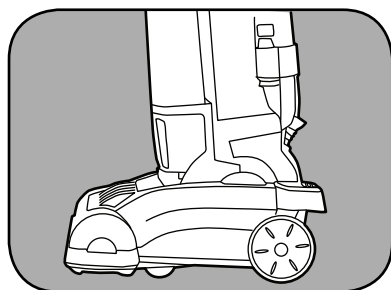

Fig. 2

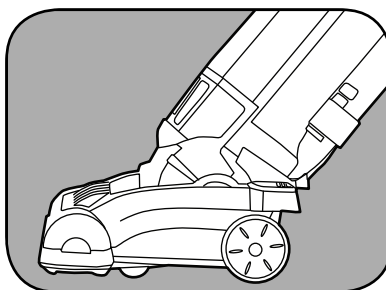

Fig. 3

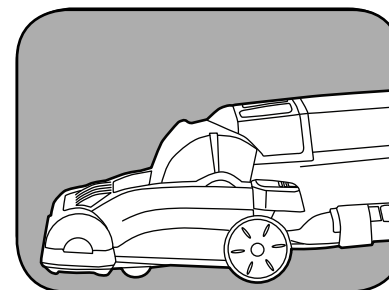

Fig. 4

# How to Attach the Extension Power Cord

## How to Attach the Extension Power Cord to the Cord Lock

1. Connect the extension power cord to the pigtail cord on the vacuum.
2. Snap the extension power cord into the slot on the end of the cord lock.
3. Turn the knob on the bottom of the cord lock to tighten the lock and prevent the cords from pulling apart (Fig. 1).

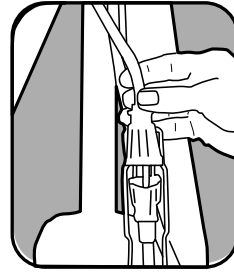

Fig. 1

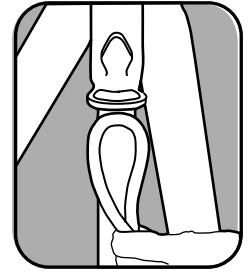

Fig. 2

## How to Attach the Cord to the Retainer Hook on the Handle

1. Create a loop in the power cord and push it through the slot and over the hook of the cord retainer (Fig. 2).
2. Pull down on the power cord to remove any slack (Fig. 3).

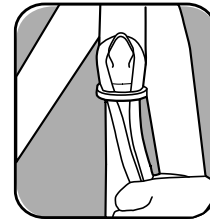
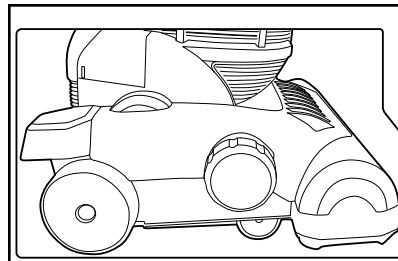

Fig. 3

# Nozzle Height Feature

The height adjust dial should be on the LOW setting at all times for optional cleaning performance on commercial carpet (Fig. 1).



Use LOW Setting for Commercial Carpet				
MAX	X-HIGH	HIGH	AUTO	LOW

Fig. 1

# Edge Cleaning Feature

The edge cleaning feature provides improved cleaning near walls and stationary furniture. For maximum edge cleaning, position the right side of the vacuum from the user's perspective near walls or stationary furniture.

# How to Change the Vacuum Bag

Always operate the vacuum cleaner with a vacuum bag installed. Bags should be changed when they are 2/3 full.

## How to Change the Vacuum Bag

1. Unplug the vacuum cleaner. Remove the bag compartment cover (Fig. 1).
2. Remove the bag from the bag holder by grasping the sides of the bag collar and pulling straight off. Attach a new vacuum bag by pushing the collar onto the inlet (Fig. 2).
3. Pull out the bottom corners of the new vacuum bag to expand the bag capacity (Fig. 3).
4. Reinsert the tab on the end of the bag compartment cover into the groove on the bag compartment housing. Press the bag compartment cover into place, closing it tightly.

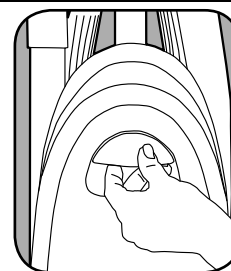

Fig. 1

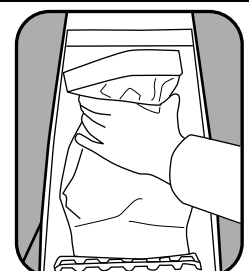

Fig. 2

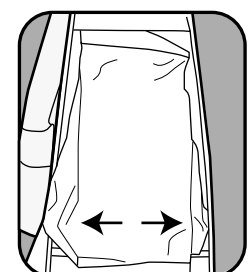

Fig. 3

# How to Change the Filters

Your vacuum cleaner is equipped with a secondary filter and a HEPA media filter. These filters capture fine dust particles and protect the motor from dirt. Accumulated dirt in the bag compartment will be collected on the filters and may restrict motor performance. It is important to change the filters regularly — approximately once a year or as needed.

## How to Change the Secondary Filter

1. Unplug the vacuum cleaner. Remove the bag compartment cover and remove the vacuum bag.
2. Remove the secondary filter by sliding it out from under the bag supporter (Fig. 1).
3. Insert a new filter, replace the bag and bag compartment cover.

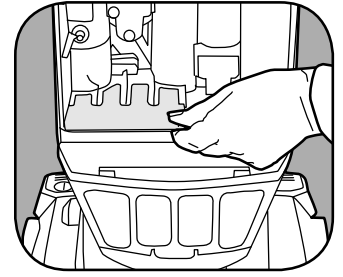

Fig. 1

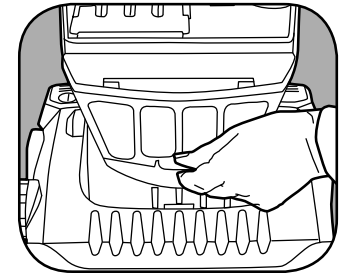

Fig. 2

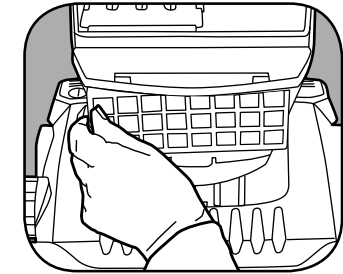

Fig. 3

## How to Change the HEPA Media Filter

1. Unplug the vacuum cleaner. Remove the filter cover below the dust compartment cover (Fig. 2).
2. Remove the filter from the front of the vacuum (Fig. 3).
3. Insert a new filter and replace the filter cover.

# Cleaning with On-Board Tools

Your vacuum cleaner is equipped with on-board cleaning tools, including a telescopic wand, stretch hose, dusting brush and a crevice tool.

1. To use the cleaning tools, lift the hose handle straight up from the vacuum (Fig. 1).
2. Extend the wand by pulling the button back and pulling the smaller wand out of the larger wand (Fig. 2).
3. Attach any of the on-board tools to the end of the wand, or if you do not need the wand, any tool can be connected directly onto the hose handle.

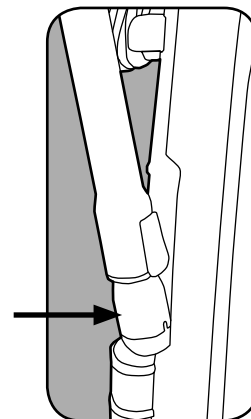

Fig. 1

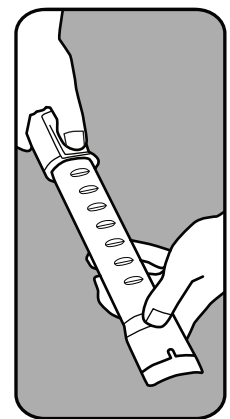

Fig. 2



# How to Replace the Vacuum Belt

**CAUTION: First unplug the vacuum cleaner.**

## How to Remove the Bottom Plate

1. Place the vacuum cleaner in the lowest position by stepping on the handle release pedal (see "How to Adjust the Handle" on page 5). Turn the vacuum over on a flat surface, exposing the bottom plate.
2. Remove the five screws holding the L-shaped bottom plate in place (Fig. 1).
3. Remove the bottom plate.

## How to Replace the Belt

1. Turn over the unit and remove the bottom plate as described above.
2. Lift out the brushroll and remove the old belt (Fig. 2).
3. Loop the new belt around the drive shaft (Fig. 3) and the raised ring between the bristles on the brushroll (Fig. 4).
4. Pull the brushroll forward (against the pull of the belt) and reinsert the ends back into the nozzle (Fig. 5) making sure to line up the end opposite the belt so the flat edges slide down properly.
5. Turn the brushroll by hand, making sure the belt is not twisted and all rotating parts move smoothly.
6. Replace the bottom plate and the five screws.

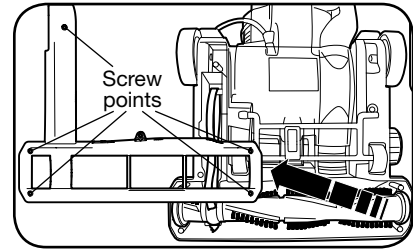

Fig. 1

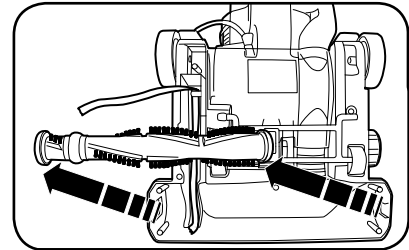

Fig. 2

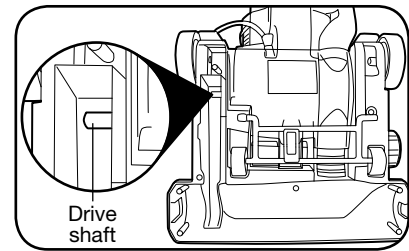

Fig. 3

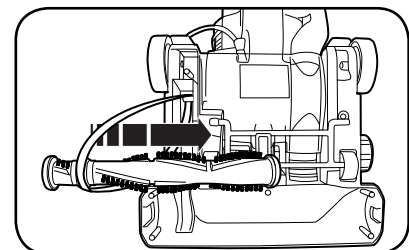

Fig. 4

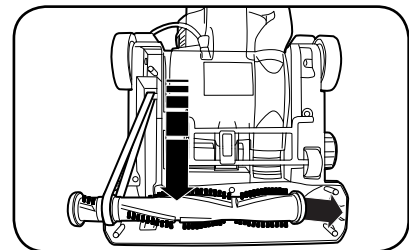

Fig. 5

# Thermal Motor Protection

Your CleanMax vacuum cleaner is equipped with a thermal protector designed to protect your vacuum cleaner from overheating due to restricted airflow (i.e. clogged hose). Should this situation occur, the thermal protector will automatically shut off the motor to prevent damage.

## **How to Reset the Thermal Protector**

1. Unplug the vacuum cleaner.
2. Allow the vacuum cleaner to cool at least 30 minutes.
3. Check for blockages, change the vacuum bag and clean or replace the filters.
4. Plug in the vacuum cleaner and begin using.

Please contact the service agent where your CleanMax vacuum was purchased with any questions.

# Troubleshooting

<b>Problem</b>	<b>Check Point</b>	<b>Possible Solution</b>
Suction power is weak.	<ul style="list-style-type: none"><li>• Vacuum bag</li><li>• Wand or hose</li><li>• Filters</li></ul>	<ul style="list-style-type: none"><li>• If the vacuum bag is 2/3 full, replace it.</li><li>• If clogged or blocked, remove the object.</li><li>• Clean or replace filters.</li></ul>
The vacuum does not work.	<ul style="list-style-type: none"><li>• Power cord</li></ul>	Insert the power plug firmly into an electrical outlet.
Sudden loss of power.	<ul style="list-style-type: none"><li>• Thermal reset</li></ul>	Turn off vacuum and unplug from electrical outlet. Let vacuum cool down for at least 30 minutes before turning back on. Check for clogs. Replace vacuum bag.
Dirt and debris are blowing through exhaust vent.	<ul style="list-style-type: none"><li>• Filters</li></ul>	Make sure filters are clean, dry and installed correctly.
All other service should be performed by the service agent where your CleanMax vacuum was purchased.		

## For Best Performance

- Keep machine and all accessories clean and in good operating condition.
- Replace the bag when it is 2/3 full.
- Replace the filters once a year or as needed.
- Always use genuine CleanMax filters and parts, as use of other products may result in poor cleaning or filtration performance. CleanMax filtration products are designed for maximum performance.
- Store machine carefully in a dry area.
- For optimum cleaning performance and safety, follow your owner's manual.

# Warranty

**What Is Covered:**

This warranty covers any defects in material and workmanship in your new CleanMax vacuum.

**How Long Coverage Lasts:**

Warranty coverage for the CleanMax vacuum lasts one year.

**What Is Not Covered:**

- Damage to the vacuum that occurs from neglect, abuse, alterations, accident, misuse or improper maintenance.
- Normal replacement items: belts, filters and disposable bags.

**What CleanMax Will Do:**

This warranty provides, at no cost to you, all labor and parts to keep this vacuum in proper operating condition during the warranted period.

**How to Get Service:**

Warranty service can only be obtained by presenting the vacuum to a CleanMax Service Center. A proof-of-purchase and product serial number will be required before service is rendered.

THIS WARRANTY IS EXCLUSIVE AND IN LIEU OF ANY AND ALL OTHER WARRANTIES WHETHER WRITTEN, ORAL, EXPRESSED OR IMPLIED, (INCLUDING ANY WARRANTY OF MERCHANTABILITY OR FITNESS FOR A PARTICULAR PURPOSE). THIS WARRANTY DISCLAIMS LIABILITY FOR INCIDENTAL OR CONSEQUENTIAL DAMAGES.

**How State Law Applies:**

This warranty gives you specific legal rights, and you may also have other rights that vary from state to state.

## Owner's Information

(keep this for your records)

The model and serial number of this product may be found on the back side of the unit. You should note the model and serial number of your unit in the spaces provided below, and retain this book as a permanent record of your purchase.

Date of purchase \_\_\_\_\_

Serial number \_\_\_\_\_

Model number \_\_\_\_\_

**Purchased from:**

Name \_\_\_\_\_

Address \_\_\_\_\_

City, State, Zip \_\_\_\_\_

Telephone \_\_\_\_\_

# CLEANMAX

CleanMax Vacuum Cleaners  
PO Box 730  
Fenton, MO 63026