

New Equipment Warranty

Limited Warranty

Mercury Floor Machines warrants new equipment against defects in material and workmanship under normal use and service to the original purchaser. Any statutory implied warranties, including any warranty of merchantability or fitness for a particular purpose, are expressly limited to the duration of this written warranty. Mercury Floor Machines will not be liable for any other damages, including but not limited to indirect or special consequential damages arising out of or in connection with the furnishing, performance, use or inability to use the machine. This remedy shall be the exclusive remedy of the purchaser. The warranty period is subject to the conditions stated below.

“Best Warranty on the Planet” – 5-Years on Motor, Transmission and Chassis

Mercury Floor Machines warrants the roto-molded body to be free from defects in material and workmanship, under normal use and service for a lifetime. Mercury Floor Machines warrants the motor and all electrical components to be free from defects in material and workmanship, under normal use and service for five (5) years from the original date of sale. Parts replaced or repaired under this warranty are warranted for the remainder of the original warranty period. Service labor charges are covered for one (1) year from the date of purchase, when performed by a manufacturer-authorized service provider.

Labor is only provided by authorized service centers. If an authorized service center is not near you, it is the purchaser's responsibility to take their machine to an authorized service center.

Critical Wear Items such as bearings, capacitors, clutches, pulleys, rectifiers, relays, switches, wheels, tires and casters are warranted for manufacturing defects for one (1) year from the purchase date. Normal Wear Items such as belts, brushes, bumpers carbon brushes, cords, finishes, squeegees, actuating cables and gaskets are warranted for manufacturing defects for ninety (90) days from the purchase date.

All warranties of motors and associated components will be voided: if the machine is serviced by anyone other than an authorized service provider; if the machine is mechanically modified; if the machine is operated when not operating properly; or if the machine is misused or abused.

The warranty starts on the purchase date by the original purchaser from Mercury Floor Machines subject to proof of purchase. The Machine Registration Card must be completed and returned immediately at the time of purchase. Registration may also be performed online at: www.sandioplastics.com/registration.aspx. If proof of purchase cannot be identified, the warranty start date is ninety (90) days after the inventory stocking date at the distributor's warehouse.



Ultimate Solutions Corporate Office
15571 Container Lane, Huntington Beach, CA 92649
Phone: 888-568-4606 | Fax: 714-901-8404
www.mercury floor machines.com

Make a copy of this card for future reference.

Copyright © 2015 Ultimate Solutions | Mercury Floor Machines. All Rights Reserved.

SAFETY, OPERATION AND MAINTENANCE MANUAL WITH PARTS LIST

Please read before use!

1.5HP, 175 RPM

REGISTER
YOUR
MACHINE
ONLINE!



HERCULES FLOOR MACHINE
Heavy-Duty Floor Machine | 6 Apron Sizes Available



Manufactured with
Pride in the U.S.A.



**ULTIMATE
SOLUTIONS**
Together We're Better!

IMPORTANT INFORMATION AND SAFETY INSTRUCTIONS

Register your Machine Online or Return your Machine Warranty Card!

Serial No: _____

Another Innovative
Product from





Dear Valued Client,

Congratulations on the purchase of your Hercules Super Heavy-Duty Floor Machine! Our Mercury machines are built to last, are durable and strong to provide optimal floor buffing, cleaning and scrubbing

Please review this manual paying careful attention to the Safety Instructions section. Keep in mind that any unnecessary damage, neglect or abuse of this machine will void your warranty. You can be confident that simple maintenance will ensure that your floor machine provides quality performance for many years to come.

If warranty questions arise, please consult your manual or contact your distributor. Should you have any questions regarding maintenance, replacing parts or ordering parts, please call an authorized distributor.

Before you begin using your floor machine, thoroughly review the Owner's Manual.

Again, congratulations on the purchase of your Hercules Super Heavy-Duty Floor Machine!

Questions or Comments?

Phone: 201-568-4606
Toll Free: 888-568-4606
Fax: 201-568-7962

Ultimate Solutions Corporate Offices:
15571 Container Lane, Huntington Beach, CA 92649

Visit our website at: www.mercuryfloormachines.com
Register your machine online at: www.mercuryfloormachines.com/registration.aspx



WARRANTY REGISTRATION

Please take a moment to register your machine. Fill out the information below and mail back to Mercury immediately.

The warranty starts on the purchase date by the original purchaser subject to proof of purchase. This Machine Registration Card must be completed and returned immediately at the time of purchase. If proof of purchase cannot be identified, the warranty start date is ninety (90) days after the inventory stocking date at the distributor's warehouse.

Your machine may also be registered online at:
www.mercuryfloormachines.com/registration.aspx

Machine Model _____ Purchase Date _____

Motor Type _____ Serial No. _____

Place of Purchase _____

Shipped To _____

Your Name _____ Phone _____

E-mail _____ Fax _____

Address Line 1 _____

Address Line 2 _____

City _____ State _____ Zip _____

Comments:

Mail to:
Mercury Floor Machines, Inc.
110 South Van Brunt Street
Englewood, NJ 07631

**See reverse side for Warranty Information.
Make a copy of this card for future reference.**

Copyright © 2015 Ultimate Solutions | Mercury Floor Machines. All Rights Reserved.

HERCULES HEAVY-DUTY FLOOR MACHINE

By Ultimate Solutions | Mercury Floor Machines

Please fill out the following information:

Model No: _____

Serial No: _____

Distributor Name: _____

Distributor Phone No: _____

Date of Purchase: _____



The Ultimate Solutions Group
Our Family of Companies
TOGETHER WE'RE BETTER!



Your Ultimate Choice in
Profitable Cleaning Performance!

Ultimate Carpet Solutions
www.sandiaplastics.com



Ultimate Hard Floor Solutions
www.mercuryfloormachines.com



Ultimate Cleaning Solutions
www.ultimatesolutionsinc.net

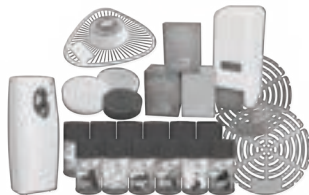

Table of Contents

Returned Material Authorization (RMA) Procedure	2
New Equipment Warranty	3
1.0 Safety Instructions	4
2.0 Grounding Instructions	5
3.0 Assembly Instructions	6
4.0 Operating Tips	8
5.0 Machine Schematic Drawing	9
6.0 Handle Parts List	10
7.0 Machine Parts List	11
8.0 Troubleshooting	12
9.0 Brush Construction	13
10.0 Pad Driver Construction	13
11.0 Scrubbing Brush Types	14
12.0 Wiring Diagram	15
13.0 Optional Parts and Accessories	16

Returned Material Authorization (RMA) Procedure

Original purchaser (distributor/service center) must contact the manufacturer to follow correct RMA/warranty procedures. Must include a copy of RMA Sheet enclosed in the box with returned item. No returns shall be authorized unless proper RMA procedures are followed. It is the responsibility of the distributor to repair the client's equipment as soon as possible. Labor is only provided by authorized service centers. If an authorized service center is not near you, it is the purchaser's responsibility to take their machine to an authorized service center.

Client must contact the distributor prior to working on or changing out any parts, etc. Manufacturer must issue an RMA Sheet containing approved labor time and replacement parts. Do not send parts or equipment back to manufacturer without an RMA number and approval. No labor will be paid for, nor part costs paid for or reimbursed that have not been previously approved by the manufacturer. All warranty work must be approved and authorized to qualify and appropriate warranty procedures must be followed.

New Equipment Warranty

"Best Warranty on the Planet" – 5-years on motor, transmission and chassis.

Warranty Policy

All equipment is inspected and tested before shipping from the manufacturer. All parts are warranted to be new and free from defects in workmanship and material, under normal use to the original retail purchaser. This warranty limits manufacturer's liability for defects in workmanship or materials for replacement of defective parts only. The manufacturer accepts no liability for incidental or consequential damages arisen from the use of any equipment, defective or not. This warranty is in lieu of all expressed or implied warranties and is extended only to the original retail purchaser. Manufacturer sales and service representatives are not authorized to waive or alter the terms of this warranty, or to increase the obligations of the manufacturer under the warranty. Parts replaced or repaired under this warranty are warranted for the remainder of the original warranty period.

Labor is only provided by authorized service centers. If an authorized service center is not near you, it is the purchaser's responsibility to take their machine to an authorized service center.

The manufacturer covers up to one (1) year (365 days) of service labor at the manufacturer's calculated hourly labor rate/repair time when performed by a manufacturer-authorized service provider. Ultimately, labor reimbursement costs are at the discretion of the manufacturer. At no time is the manufacturer responsible for travel time to complete on-call repairs. After one (1) year, the original retail purchaser is responsible for all labor costs with no manufacturer reimbursement.

The original purchaser must contact the manufacturer to follow correct RMA/warranty procedures. They must include a copy of the RMA Sheet enclosed in the box with the returned item. No returns shall be authorized unless the proper RMA procedures are followed. It is the responsibility of the distributor to repair the client's equipment as soon as possible.

The manufacturer charges a 25% restocking fee for any items that are being returned to stock. Items must be new, unused, free of damage and are only good for up to 30 days. After 30 days, the manufacturer does not accept the return of any items for a store credit.

Authorized warranty replacement parts need to come directly from the manufacturer. Any use of any other parts will void warranty. The manufacturer does not reimburse for parts used by client that were not supplied directly for the machine under warranty.

The client must contact the manufacturer prior to working on or changing out of any parts, etc. The manufacturer must issue an RMA Sheet containing approved labor time and replacement parts. Do not send parts or equipment back to the manufacturer without an RMA Number and approval. No labor will be paid for, nor parts cost paid for or reimbursed, that have not previously been approved by the manufacturer. All warranty work must be approved and authorized to qualify, and appropriate warranty procedures must be followed.

The warranty starts on the purchase date by the original purchaser from an authorized distributor, subject to proof of purchase. The Machine Registration Form must be completed and sent to the original manufacturer at the time of purchase. If proof of purchase cannot be identified, the warranty start date is ninety (90) days after the date of sale to an authorized distributor.

Register your machine online at: www.mercuryfloormachines.com/registration.aspx

13.0 Optional Parts and Accessories

Pad Drivers

Includes Riser and 92 Clutch Plate

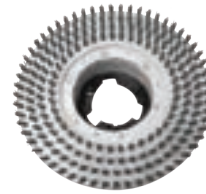

Optional 1305
12" Short Bristle
Pad Driver



Optional 1505
14" Short Bristle
Pad Driver



Optional 1705
16" Short Bristle
Pad Driver

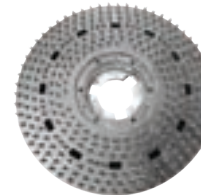

Optional 1905
18" Short Bristle
Pad Driver



Optional 2105
19" Short Bristle
Pad Driver

Accessories



Optional Unicorn
Weight Kit: add up to 50
extra pounds of pressure
UWK



Optional Solution Tank:
for efficient wet scrubbing
SST-4

12.0 Machine Wiring Diagram

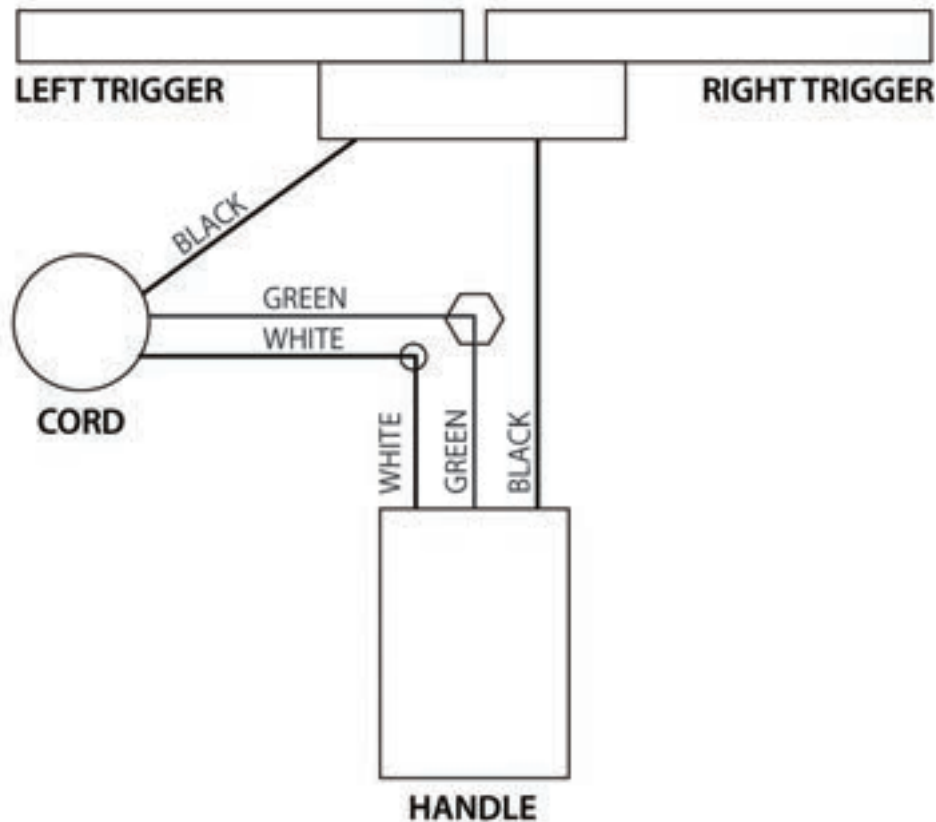

1.0 Safety Instructions

READ THIS MANUAL BEFORE OPERATING MACHINERY. KNOW THE PROPER SET-UP, OPERATION, CORRECT APPLICATIONS AND THE LIMITATIONS OF THIS EQUIPMENT **BEFORE** USE.

This floor machine will afford you many years of trouble-free operating satisfaction, provided it is given the proper care. All parts have passed rigid quality control standards throughout the assembly process. Prior to packaging, your floor machine was again inspected for assurance of flawless operation.

This floor machine is protectively packed to prevent damage in shipment. We recommend that upon delivery, unpack the unit and inspect it for any possible damage. Only a visual inspection will reveal damage that may have occurred.

If damage is discovered, immediately notify the transportation company that delivered your machine. As a shipper, we are unable to report any claim for damage. You must originate any claim within five (5) days.

This manual is for your protection and information. Please read it carefully since failure to follow precautions could result in discomfort or injury.

Reduce the Risk of Fire, Electric Shock or Injury

DO NOT USE ON WET SURFACES OR EXPOSE TO RAIN. STORE INDOORS.

Use only as described in this safety operating manual. Use only the manufacturer's recommended attachments, accessories and replacement parts. Replace damaged or worn parts immediately with genuine, original equipment parts to maintain safety and to protect your limited warranty.

Always turn OFF the machine before changing brushes, pad drivers or servicing your machine. This machine must be connected to a properly grounded outlet only (see grounding instructions). The extension cord provided with this unit is 50-foot, 14/3-gauge wire and **MUST** be used with this unit to ensure grounding protection. Turn off all controls before unplugging. This is not a toy. Close attention is necessary when used around or near children. Train your staff in proper use of this floor machine to avoid injury.

- DO NOT use outdoors or expose to rain. This floor machine is designed for indoor use only.
- DO NOT wash the motor with flowing water. If the motor gets wet, seek authorized service.
- DO NOT handle this electrical equipment with wet hands. DO NOT operate this machine with bare feet.
- DO NOT operate this equipment near flammable dusts, liquids or vapors. DO NOT use flammable solvents as a cleaning agent. Engine sparks and operating heat can cause fire.
- DO NOT operate with the motor covered or with vents blocked. Keep the vents on this air-cooled motor free from debris.
- DO NOT use this machine as a floor sander.
- DO NOT operate over sharp objects that may harm the operator and damage the floor. Sweep hard floors before scrubbing or buffing. Vacuum clean carpets before shampooing or bonnet cleaning.



1.0 Safety Instructions Continued

Reduce the Risk of Fire, Electric Shock or Injury.

- DO NOT leave the machine when plugged in. Unplug it from the outlet when not in use and before servicing.
- DO NOT use this machine with a damaged handle controls, cord or plug. If it is not performing properly, contact an authorized service center and seek repair.
- DO NOT unplug the machine by pulling the cord. To unplug, grasp the plug, not the cord. DO NOT pull by the cord, close a door on the cord, pull the cord around sharp edges or corners or drive equipment over it. Keep the cord away from heated surfaces.
- DO NOT overstretch the safety power cord between the machine and the electrical outlet in the wall.

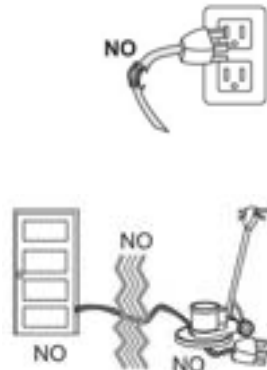

2.0 Grounding Instructions

DANGER: IMPROPER GROUNDING METHOD CAN RESULT IN A RISK OF ELECTRIC SHOCK!

Electrical equipment must be grounded. Improper connection of the equipment grounding conductor can result in a risk of electric shock. If the equipment should malfunction or breakdown, grounding provides a path of least resistance for electrical current to reduce the risk of electric shock.

This machine is equipped with a cord containing a grounding conductor and grounding plug. The plug must be inserted into an appropriate outlet that is properly installed and grounded in accordance with all local codes and ordinances.

Check with a qualified electrician or service person if you are in doubt as to whether the outlet is properly grounded. DO NOT modify the plug provided with the equipment. If it will not fit into the outlet, have a proper outlet installed by a qualified electrician.

If repair or replacement of the cord or plug is necessary, DO NOT connect the grounded wire to a flat bed terminal. The wire with insulation having an outer surface that is green with or without yellow stripes is the grounding wire.

NOTE: In Canada, the use of a temporary adapter is not permitted by the Canadian Electrical Code.

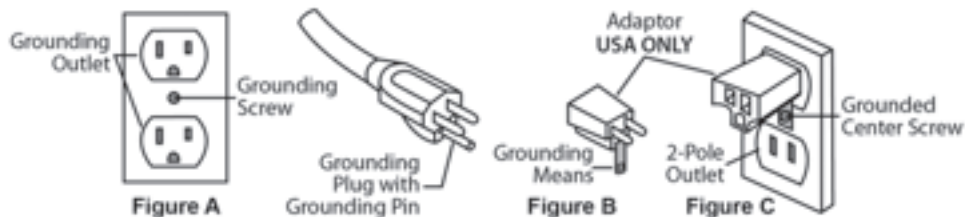

This electric equipment is for use on a normal 120 volt circuit. It has a grounded plug that looks like the plug illustrated in (Fig A). A temporary adapter, such as illustrated in (Fig B and C), may be used to connect this plug into a two-pole receptacle, as shown in (Fig B), if a properly grounded outlet is not available.

11.0 Scrubbing Brush Types

Scrubbing brushes are available with a range of bristle types from the softest for high gloss floors, to the most aggressive for heavy soils. Match your brush to the floor as you match a detergent with the soils.



Nylon is used for general scrubbing. Because nylon softens when wet, it is great for gentle scrubbing, mopping and polishing of decorative floors. Nylon will not scratch tile, terrazzo or coated surfaces. Nylon brushes are durable and long lasting.

Polypropylene is a common choice for general purpose scrubbing and works well on both concrete and on coated floors. Polypropylene brushes typically cost less than nylon, but do not last as long.

Non-scuff poly is a finer diameter (0.015-0.018”) filament used for lighter duty scrubbing conditions and on waxed or finished floors.

Bassine is a soft, natural fiber. The end of the bristle splits or “flags” to build a polishing surface.

Union mix is a mixture of bassine and tampico (another natural fiber). The mixture is stiffer than bassine alone and is used by more traditional cleaners for scrubbing. It is often replaced by poly.

Soft abrasive bristle is a 0.018” nylon filament extruded with a 500 grade grit. It is used for gentle scrubbing and is as aggressive as a white scrub pad.

Daily abrasive bristle is a 0.035” nylon filament with 180 grade grit. It is used for daily scrubbing of resilient tile and finished floors and is as aggressive as a red scrub pad.

Stripper abrasive bristle is a 0.022” nylon filament with 120 grade grit. It is used for aggressive scrubbing and light stripping of resilient floors, terrazzo and concrete. It is as aggressive as a blue scrub pad.

Heavy-duty stripper abrasive bristle is a 0.050” nylon filament with 80 grade grit. It is used for very aggressive scrubbing and stripping of concrete, brick and quarry tile. It is as aggressive as a black scrub / strip pad.

9.0 Brush Construction

Your new floor machine provides reliable, efficient, safe power to your scrubbing brush. To get the best results, you need to use a brush of the best design and construction.

Your floor machine is built with a “B” style drive plug (1). The height and width of the ears on the plug will match a “B” style or “Universal” clutch plate (2) mounted on the brush block.

The brush block (3) is constructed of molded plastic or plywood. Use a brush with a block diameter 2” less than your machine apron size.

The bristle material (4) that actually does the scrubbing is typically 1-1/2” to 2” long. Holes are drilled in the block and bundles of bristles are folded in half, forced into the hole and stapled in place.

When the bristles wear down to less than 1/2” long, they have little flexibility and it’s time to replace. Bristle materials are described on the next page.

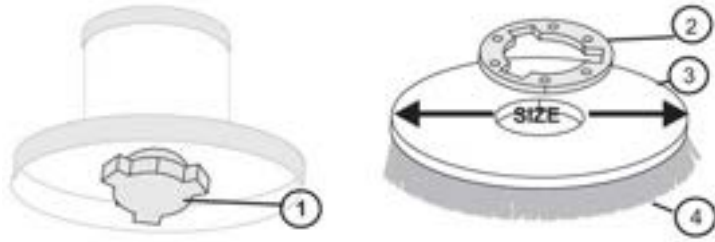

10.0 Pad Driver Construction

If you scrub or polish with a non-woven pad, use a pad driver to connect the pad to the machine.

The brush block (3) is constructed of molded plastic, fit with shorter, stiffer, pad-holding bristles (5) or “velcro-like” pad-holding hooks (6) and use a riser (7) to create extra clearance between the block and the machine apron. With this construction, use a pad driver with block diameter 1” less than your machine apron size.

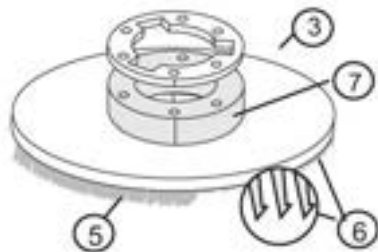

Machine Apron Size	13”	15”	17”	19”	20”	21”
Pad Driver - with 3/4” Riser	12”	14”	16”	18”	20”	20”
Brush - with NO RISER	11”	13”	15”	17”	19”	19”

2.0 Grounding Instructions Continued

DANGER: IMPROPER GROUNDING METHOD CAN RESULT IN A RISK OF ELECTRIC SHOCK!

The temporary adapter should be used only until a properly grounded outlet (Fig A) can be installed by a qualified electrician. The green color rigid ear lug or the like extending from the adapter must be connected to a permanent ground such as a properly grounded outlet box cover. Whenever the adapter is used, it must be held in place by a metal screw.

The floor machine is built with a 50 foot (15 M), 14/3-gauge safety power cord which plugs directly into an approved outlet. Use of any extension cords is NEVER RECOMMENDED.

3.0 Assembly Instructions

3.1 Install the Handle

This machine handle (1) has been custom fit to its mounting yoke (2) at the factory and then taken apart for shipping. For easy assembly, make sure that the handle number on the tag (see right) matches the serial number stamped on the chassis.

You will need 7/16” wrenches to complete this assembly:

1. Remove the handle and mounting hardware from the carton. Bolts, nuts, washers and a locking lever assembly are in the plastic bag attached to the handle.
2. Position the handle (1) over the mounting yoke (2) with the power cord (3) facing away from the motor. Push the tube down until the bolt holes are lined up.
3. Insert the mounting bolts (4) into the bolt holes from the back of the machine. Secure each bolt with a locking nut (5). The locking nuts will face the motor.
4. The handle mounting collar (6) is designed to slide freely up and down the handle tube. This feature allows the handle to be adjusted for the comfortable operation of all users. Align the mounting collar (6) and the two bent handle braces (7).
5. Remove the lever assembly parts from the plastic bag.
 - Place the thick spacer with a rectangular hole (9) onto the locking lever shaft (8). The spacer must fit onto the rectangular neck of the lever.
 - Insert the shaft through the mounting hole in the right handle brace, the mounting collar and the left handle brace.
 - Place the spacer (10) on the shaft.
 - Place the split washer (11) on the shaft.
 - Adjust the wing nut for tightness. When correctly installed, the collar slides easily when the cam-engineered locking lever is “up,” but is firmly fixed when the lever is “down.”



3.0 Assembly Instructions Continued

3.2 Attach the Power Cord

The triple-wire grounded power cord has been factory-installed into the handle tube. A flexible rubber cable connector (11) is used to secure the plug-in connections. The floor machine ships with this connector mounted on the cord coming out of the handle (10). Stretch the connector and slip the male connector (9), coming out of the motor housing, through the connector hole and then into the female connector.

Now, plug the end of the 50-foot cord into a grounded power outlet. Squeeze the triggers on the handle and check for power to the motor.

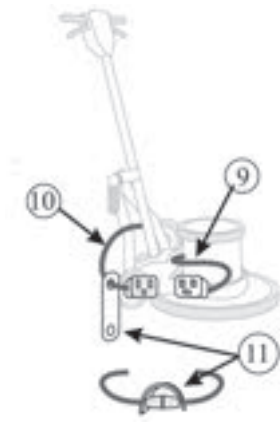

3.2 Install a Brush or Pad Driver

A brush or pad driver mounts onto your floor machine with a “B” style Universal clutch plate.

Unplug the floor machine. Lock the machine handle in the “up” position and tip the floor machine back onto the handle.

Slide the brush or pad driver clutch plate (12) over the drive plug (13).

Give the brush a quick counter-clockwise spin to lock the brush onto the drive plug.

Now, lower the machine back onto the brush. You’re ready to go to work.

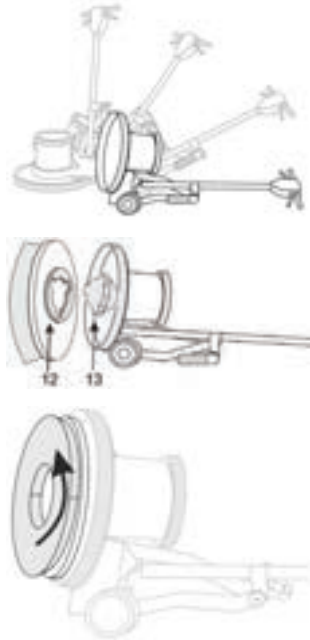

4.0 Operating Tips

4.2 Transporting your Floor Machine

To transport this floor machine from the janitor’s closet to the work area:

- Lock the handle in the “up” position. Wind the cord around the handles and the bottom cord hook.
- Tip the machine back onto the transport wheels. Push or pull the machine by the handle, not by the cord or any other part of the machine. Travel carefully



8.0 Troubleshooting

CAUTION: Always disconnect power cord before servicing the floor machine.

WARNING: Never operate the floor machine when it is not performing as expected or when any part is visibly damaged. Repairs should only be performed by an authorized service center. Failure to do so will VOID warranty.

8.1 Floor Machine will not Run

- Equipment is unplugged: check plug wall and at machine base. Plug in.
- Circuit breakers are tripped in the building: check and reset.
- Power cord failure: test with a working power cord. Lock the handle up and tip the motor back. Unplug the cord at the motor and plug the motor into your working power cord.

IMPORTANT! THIS IS JUST FOR TESTING. When you do this, you have removed the safety handle controls from the circuit and you are sending power directly to the motor. If the motor now spins, the problem is in the cord of the handle assembly. Seek authorized service center. If the motor still does not spin, the problem is either in the male connection at the motor base or in the motor. Seek authorized service center.

- Motor sparks or smokes: seek authorized service center.

8.2 Electrical Shock to Operator

- Equipment wiring failure or electrical short in the machine: seek authorized service center.
- Poor grounding or no grounding: test the outlet with a ground fault interrupter. Retain certified electrician to inspect and repair grounding. NEVER clip off the ground plug on your cord.
- Repeated circuit breaking: high amp draw and circuit breaking can be an electrical or mechanical problem. Seek authorized service center.

8.3 High Vibration

- Pads are not centered on the pad driver: tip machine back and re-center the pad.
- Uneven wear or warp to pad or brushes: replace.
- Machine chassis is damaged by dropping: replace.

7.0 Machine Parts List

Drawing No.	Item No.	Description	Quantity
37	B-8	Acorn Nut for Yoke Pin	2.00
38	B-5	Rubber Spacer	2.00
39	B-7	Yoke Pin	1.00
40	A-1001	Yoke	1.00
41	B-30	Spring	2.00
42	B-29	1/2" Flat Washer	2.00
43	M-245	6" Wheel	2.00
44	B-51	Spring Washer	4.00
45	V0038	Hub Cap	2.00
46	A-166	Main Machine Frame	1.00
47	B-95	Base Casting Screw	3.00
48A	M-232-13/Y	Bumper 13" - Yellow	1.00
48B	M-232-15/Y	Bumper 15" - Yellow	1.00
48C	M-232-17/Y	Bumper 17" - Yellow	1.00
48D	M-232-19/Y	Bumper 19" - Yellow	1.00
48E	M-232-21/Y	Bumper 21" - Yellow	1.00
49A	A-163	Apron 13"	1.00
49B	A-167	Apron 15"	1.00
49C	A-169	Apron 17"	1.00
49D	A-171	Apron 19"	1.00
49E	A-172	Apron 21"	1.00
50	B-50	Apron Plug	1.00
51	B-31	Cap Screw	4.00
52	MOTOR 1.5 HP/GB	66 Frame Motor, 1.5 HP with Gearbox, 115V	1.00
53	M-240	Axel	1.00
54	M-248	Cork Drip Cap Cover	1.00
55	M-239-Y	66 Frame Drip Cap Bumper Cover - Yellow	1.00
56	M-242-1A-Y	66 Frame Drip Cap Cover - Yellow	1.00
57	B-151	Drip Cap Mounting Screw	3.00
58	G-14-50-Y	50-Foot, 14/3-Gauge Power Cable - Yellow	1.00

4.0 Operating Tips

For indoor use only. Sweep abrasive soils before scrubbing. While the brush or pad driver is spinning, keep the floor machine moving to avoid "donut" burns on the floor.

4.1 Starting your Floor Machine

- Unlock the handle by raising the locking lever.
- Lower the handle to a comfortable position, typically waist high.
- Re-lock the handle by pushing the lever down. **DO NOT OPERATE THE MACHINE WITH THE HANDLE UNLOCKED.**
- This floor machine has a high torque motor. Hold the machine firmly with both hands when starting up.
- Use your index finger to lift the safety interlock lever up.
- Squeeze the dual triggers to release power to the motor. Once power is on, either trigger will keep power to the motor.
- To stop the floor machine release both triggers.
- The spinning brush helps move the floor machine. Lift the handle slightly to work to the right. Push the handle down slightly to work to the left.



SET HANDLE HEIGHT

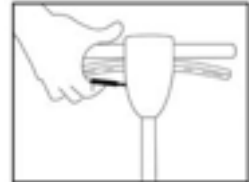

LIFT LOCK UP

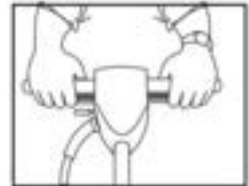

SQUEEZE BOTH TRIGGERS

4.2 Storing your Floor Machine

- Lock the handle in the "up" position. Tilt the machine back and remove the pad driver or brush.
- Wind the cord around the handles and the bottom cord hook.
- Wash brushes or pads and hang to dry. Never store machine standing on the brush.
- Check and clean pads after each operation. Remove soil and chemical buildup. Replace worn or damaged pads.
- Check the triggers and switches for proper operation.
- Repair or replace damaged skirts and dumpers.
- Use air pressure or vacuum to remove dust and debris from the motor vents.
- Inspect and maintain equipment on a regular schedule for best results.
- See an authorized service center for repairs.

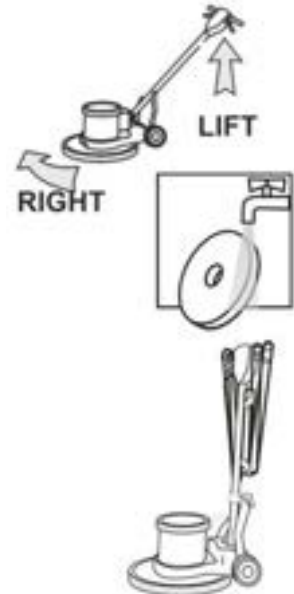

CONTINUED on Page 12

5.0 Machine Schematic Drawing

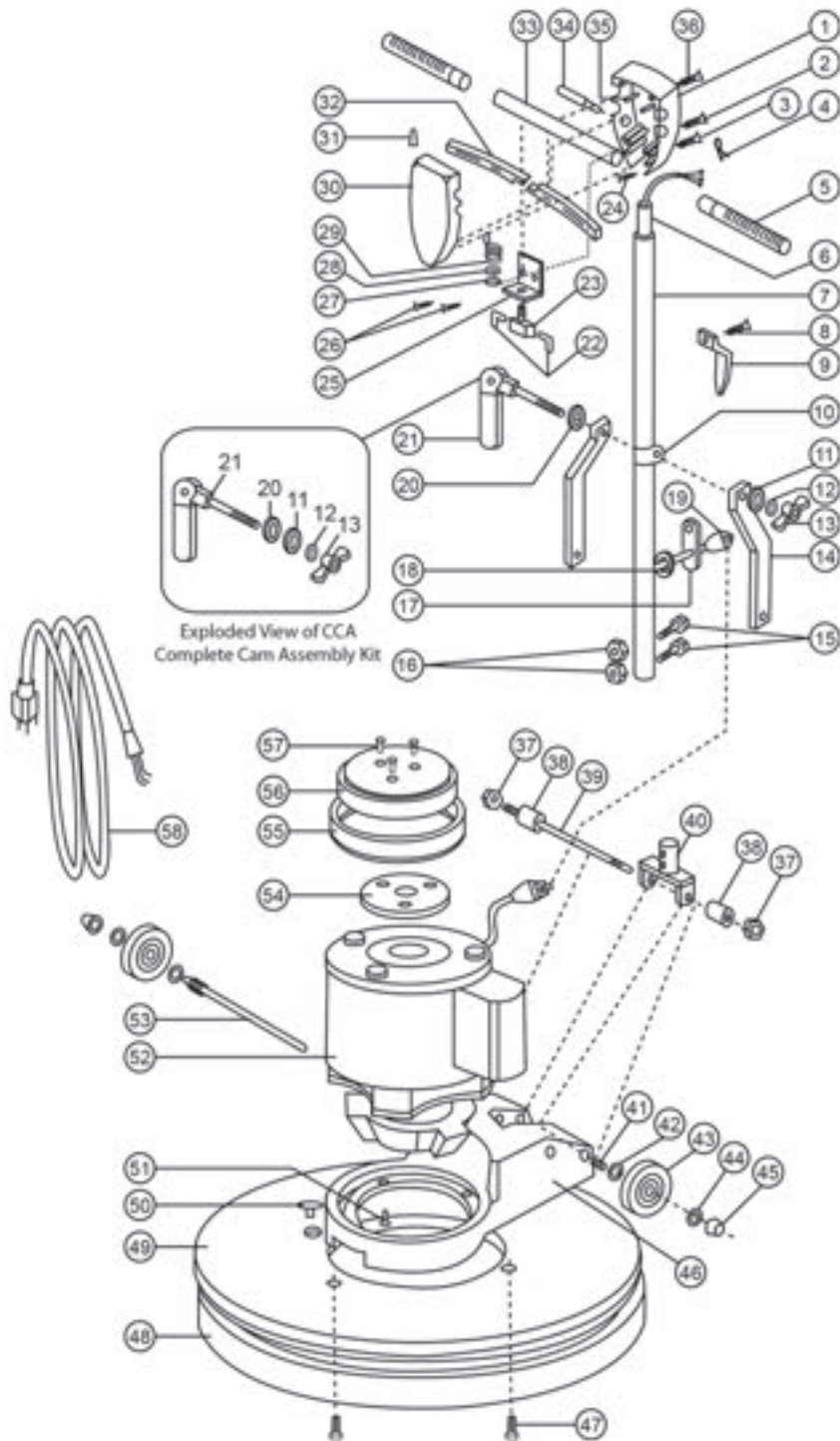

6.0 Handle Parts List

Drawing No.	Item No.	Description	Quantity
1	A-104	Switch Box Back	1.00
2	B-23	Handle Tube Screw	2.00
3	B-21	Switch Box Closing Screw	4.00
4	M-213	Strain Relief Clip	1.00
5	M-218-Y	Hand Grip with Rubber Spacer - Yellow	2.00
6	M-247	Handle Tube Insert	1.00
7	M-206	Handle Tube Assembly	1.00
8	B-2	Cable Hook Screw	2.00
9	A-164	Cable Hook	1.00
10	A-111	Sliding Collar	1.00
11	B-37	Cam Washer	1.00
12	B-39	Cam Split Washer	1.00
13	B-25	Cam Lock Wing Nut	1.00
14	M-216	Bent Brace	2.00
15	B-18A	Yoke Bolt	2.00
16	B-19	Yoke Nut	2.00
17	M-249	Black Rubber Cable Connector	1.00
18	B-63	Cable Grommet	1.00
19	G-16	Handle Tube Cable	1.00
20	B-67	Rectangular Hole Came Washer	1.00
21	C-100-1	Cam Handle Assembly	1.00
	CCA (See Exploded View)	Complete Cam Assembly Kit (Includes 1 of each drawing: 21, 20, 11,12, 13)	1.00
22	G-48	Insulated Flag Wire Connector	2.00
23	G-30-A	On/Off Switch Plate Assembly	1.00
24	B-68	Ground Wire Screw	2.00
25	G-30-B	Switch Mounting Plate	1.00
26	B-1	Switch Plate Screw	2.00
27	B-35	Int. Tooth Lock Washer for Switch	1.00
28	B-33	Lock Washer	1.00
29	G-30-CT057	Trigger Return Spring	1.00
30	A-103	Switch Box Front	1.00
31	G-47	Wire Connector	1.00
32	A-105	Trigger	2.00
33	M-211-A	16" Crossbar	1.00
34	SIA-1	Safety Interlock Assembly	1.00
35	B-70	Trigger Pin	2.00
36	B-22	Crossbar Screw	2.00